

8800 Controller

Multichannel gas & flame monitoring system



Description

The 8800 controller combines the reliability of our proven 7800 controller with advanced upgrades in one low cost package.

The 8800 controller provides simultaneous display and alarm functions for up to 16 input variables. 8 or 16 channel display modes, and I/O modules arranged in groups of 8 channels, allow economical configuration of systems. This easy-to-configure, user friendly controller is ideal for centralizing display and alarm functions in critical multipoint monitoring applications.

Features

- 8/16 channel display modes accept inputs from many sensor types and signal ranges. Input types include 4-20mA and Modbus
- Ethernet with Modbus TCP server/client and web server for configuration and monitoring
- RS-485 serial ports allow simultaneous Modbus Master/Slave operation. Two standard ports and two optional isolated ports
- Three independent alarm levels per channel. "Relay Acknowledge" feature allows silencing of external audible devices during alarm conditions
- QVGA Color LCD displays monitored data as trends, bar graphs and engineering units. Readouts change colors to indicate alarms
- Five standard SPDT 5-amp alarm relays. HORN, FAULT and three programmable alarm relays
- Options cards such as 4-20mA inputs, 4-20mA outputs, discrete and programmable alarm relays
- Cal Mode offers push-button zero/span calibration for remote sensor applications
- Authorization Mode allows locking of critical settings
- Data Logger onto SD card allows recording of input values, and events for more than 10 years
- Power supply options include both 150 and 600 Watt
- Magnetic keypad standard for non-intrusive operation in potentially hazardous locations
- Enclosures include wall mount NEMA 4X - Non-Metallic, 316 SS, XP and Rack/Panel Mount



8800 Controller

Specifications

8800 Controller

Input	12 bit 4-20mA into 150 ohms input impedance; includes +power supply terminals for each channel for routing power to two or three wire transmitters
Serial Ports	Two standard RS485 ports Two additional isolated ports optional
Ethernet Port	Modbus TCP Master/Slave port with web server (Gateway for Ethernet IP, Bacnet, and other protocols available)
Alarm Relays	5 amp 30VDC or 250VAC resistive Form C
Analog Outputs (Optional)	16 bit 4-20mA output. Max load 800 ohms with nominal 24VDC power supply
Alarm Reset	Two 10-60VDC Alarm Reset Input Terminals
Digital Output	400mA @ VDC
Display	QVGA 320 x 240 pixel TFT graphic LCD with LED backlight
Ambient Temperature Range	-25 – +60 degrees C
Power Supply	10 – 30VDC (24VDC nominal) 12 Watts max required 10-0172 option = 150 Watt 10-0307 option = 600 Watt
Approvals	CE Approved CSA C22.2 No 1010.1 and C22.2 No.152 for combustibles and ISA S82.02 CSA Class I Div 2 Grps A, B, C, D

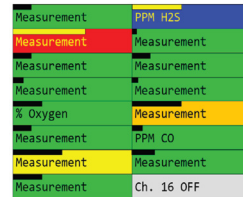

MAIN DATA SCREEN

Displays all active channels on the same screen. Channel configurations include 16, active channels. Cells indicate alarm status by color.

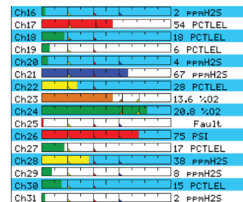

BAR GRAPH SCREEN

Displays 16 channels at a time. Bar graphs change colors to indicate alarm status.

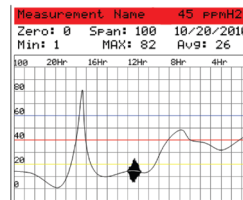

24 HOUR TREND SCREEN

Displays 1 channel at a time as most recent 24 hour trend. Top data fields include current reading, max – min – average readings over the 24 hours, range, channel ID and engineering units.

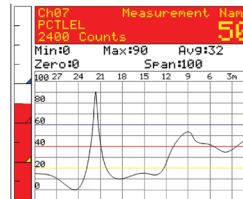

COMBINATION SCREEN

Displays 1 channel at a time as most recent 30-minute trend, bar graph and large engineering units. Top data fields include current reading, max - min -average readings for trouble shooting, range, channel ID, and engineering units. Readings change color and flash on alarms. Flashing color becomes steady after acknowledge.

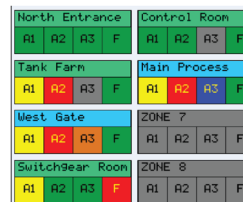

ZONE SCREEN

Displays all eight possible active zones. Alarm cells change colors and name field flashes indicating alarms. Allows user direct access to screen that shows which channels belong to each zone.

8800 Controller Nema 4X Wall Mount

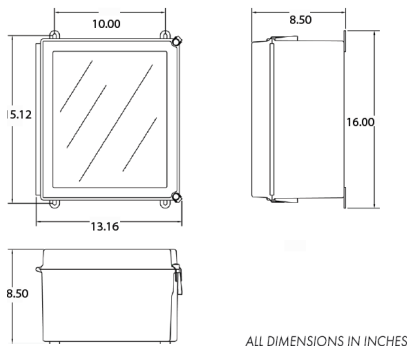

8800 Controller Nema 7 Explosion Proof

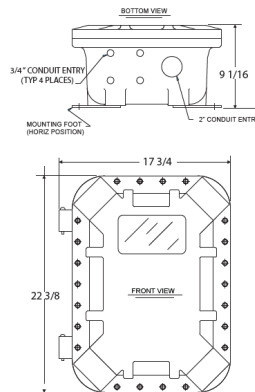

8800 Controller Rack/Panel Mount
(19" Rack Spreader Plates Not Shown)

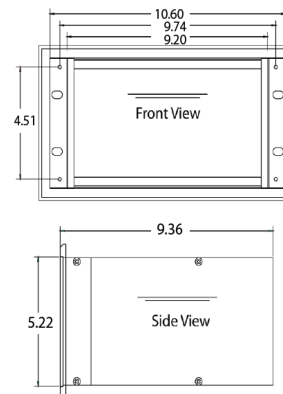

Teledyne Gas & Flame Detection quality assurance programmes demand the continuous assessment and improvement of all our products. Information in this leaflet could thus change without notification and does not constitute a product specification. For more information, please contact us or your company representative



AMERICAS
14880 Skinner Rd
Cypress, TX 77429,
USA
Tel.: +1 713-559-9200

EMEA
ZI Est, Rue Orfila,
CS 20417
62027 ARRAS CEDEX, France
Tel.: +33-3-21-60-80-80
Fax: +33-3-21-60-80-00

ASIA PACIFIC
Room 04, 9th Floor, 275 Ruiping
Road,
Xuhui District, Shanghai,
China
TGFD_APAC@teledyne.com